

EZ-Path® Series 44+ Single Split Wall Plate for Retro-Fit Applications CATALOG NUMBER EZP144RS, EZDP144RS & EZDP144RS2

TABLE A: CONTENTS

Qty.	Description
4	Plate Half
2	Firestop Gasket
12	10-32 X 5/16" Screws
4	10-32 Nuts
1	EZD44S (EZDP144RS Only) / EZD44S2 (EZDP144RS2 Only)
1	EZ-Path Retro-Fit Template

The Split Wall Plate is engineered to facilitate the installation of the EZ-Path® Series 44+ pathway in fire-rated walls. The pathway is designed to be installed in up to a 6 in. (152 mm) diameter round opening. The plate is comprised of two halves that are secured together using screws and nuts and can be pre assembled or assembled around the pathway. The two-piece plates and split intumescent gaskets are designed to make possible installations around existing cable bundles or to replace non self sealing sleeves. Suitable drywall or concrete anchors (purchased separately) may be required to fasten the assembled pathway/plate to the wall. Check appropriate UL Classified design for additional information.

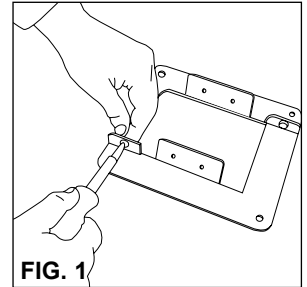

FIG. 1

Before installing, using split gasket as a template, confirm that the assembled plates will overlap the wall openings on both sides by a minimum of 1" (25 mm) at the four corners and by 1/4" (6 mm) everywhere else. When required, verify that fasteners will attach solidly to undamaged, structurally intact wall surfaces.

NOTE: Pathway is designed to be installed through walls with the lid (labeled surface) facing upwards.

NEW WORK INSTALLATIONS

1. Assemble wall plates by using two (2) #10-32 x 5/16" screws and #10-32 nuts (included-see Fig. 1). Using the assembled plate as a template, determine best installation position for BOTH sides of wall that will allow proper alignment of the pathway through the wall. Openings when properly aligned, should allow the pathway to be inserted through the wall on a level path, perpendicular to wall surface. Adjust plate as required to align pathway openings and to meet the attachment requirements listed above. Once properly positioned, mark the location of the four wall fasteners (if necessary). Remove plate from wall surface and drill holes for fasteners (if necessary).
2. Slide pathway into opening in wall plate. Pre position and fasten wall plate to one side of pathway (Fig. 2) roughly centering pathway within barrier.
3. Slide gasket onto pathway (See Fig. 3) so that when inserted into wall, gasket will be sandwiched between plate and wall.
4. Insert pathway into wall opening. If necessary, align plate/pathway with previously drilled holes and secure to wall using appropriate fasteners.
5. Moving to the opposite side of the wall, install remaining gasket and wall plate as detailed above. Tighten set screws to complete installation.

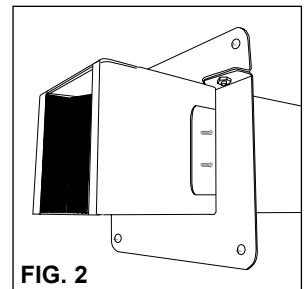

FIG. 2

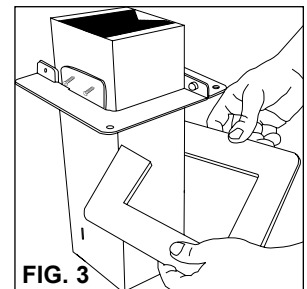
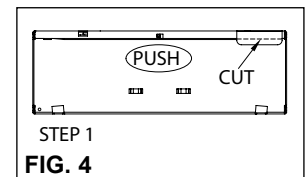

FIG. 3

OLD WORK INSTALLATIONS AROUND CABLES

1. Cut label at seam of pathway on both sides and place pathway on a flat surface with the lock at center of pathway facing up (See Fig. 4).
2. Push down slightly on the channel below the lock, slide lid to the left to deactivate lock and remove lid (See Fig. 5).
3. Cut and remove elastic band wrapped around intumescent pads and remove top intumescent pad.
4. Place pathway U-channel around cable bundle.



STEP 1

FIG. 4

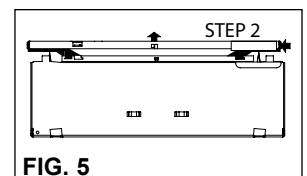

STEP 2

FIG. 5

5. Replace intumescent pad within lid and align slot in lid over channel lock (See Fig. 6).
6. Slide slot in lid over channel lock to full extent and slide pathway lid to the right to reactivate lock (See Fig. 7).
7. Position wall plate sections around cable bundle (between pathway and wall surface) and assemble and finish installation per steps 1 through 5 from instructions on New Work Installations above.

NOTE: This type of installation requires the pathway to be disassembled, installed around cables, and then re-assembled. Wall plates must also be assembled around the cable bundle. This action will require a minimum of 16" (406 mm) of unrestricted space and unobstructed access to cable bundle on one side of the wall.

INSTALLATIONS AROUND PREVIOUSLY INSTALLED NOM 4" DIAMETER SLEEVES IN GYPSUM WALLS

1. If the sleeve incorporates escutcheons, remove them at this time. Keep sleeve temporarily in the opening for protection of cables.
2. Using provided template, align template at top of sleeve and trace around outer edge of template (See Fig 8).
3. Using a key-hole saw, cut on the outside edge of traced lines (See Fig 9) to form a "U" shaped opening.
4. Remove 4" sleeve from opening.
5. Follow instructions for Old Work Installations Around Cables above.

INSTALLING OR PULLING CABLES

A resilient liner provides an adjustable seal within the pathway device. Liner must be protected from damage while adding or removing cables. Wrap cable ends with a suitable low friction tape before inserting into the pathway. Where cable lubricants are used, low solids, water-based products are recommended. This device is designed to be fully functional at all cable loadings from completely empty to visually filled, and cables should easily slide through the pathway using minimal effort. IF RESISTANCE IS ENCOUNTERED, DO NOT FORCE CABLES OR CABLE BUNDLES THROUGH THE PATHWAY. DAMAGE MAY RESULT. Upper curved liner may be depressed when inserting cables, if necessary, using a flat, smooth implement and then removing it after cables are installed. The rectangular shape of the loading area coupled with gentle pressure exerted by resilient liners will naturally distribute the cables at a relatively uniform height across the width of the device. The use of a cable dressing/combining instrument to straighten and organize cables may help to maximize usable space within the pathway device.

GROUNDING

At the option of the installer, this pathway may be grounded. After pathway has been installed, insert ground screws where indicated (See Fig. 10).

WALL LABELING

Wall labels are provided with the pathway as well as wall plate kits. Larger orange colored label is intended to be used to identify the pathway installer as well as to provide applicable UL System information. Smaller secondary labels are included with multi-gang wall brackets as an optional method for identifying or marking cable types, uses, or trades. Two sets of labels are provided for marking both sides of wall.

MAINTENANCE

No maintenance of the pathway is normally required. Interior of device should be inspected before and after any modifications to cable bundle. If any damage to intumescent pads lining top and bottom of the pathway is found, contact the factory to determine if replacement is required.

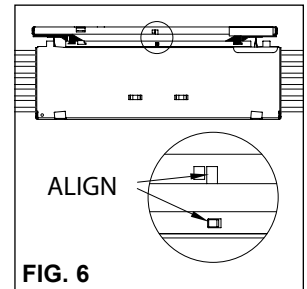

FIG. 6

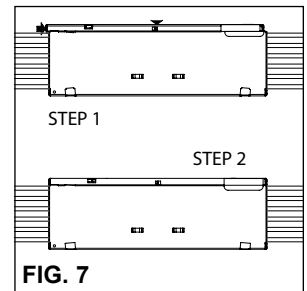

FIG. 7

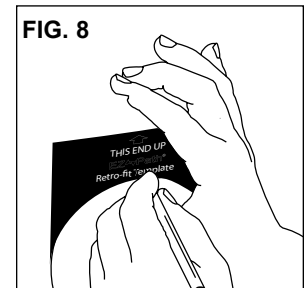

FIG. 8

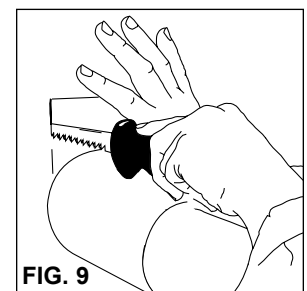

FIG. 9

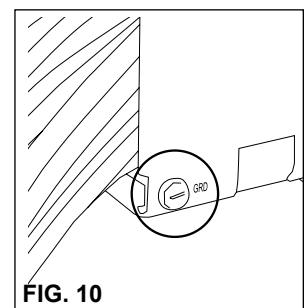

FIG. 10

IMPORTANT NOTICE: All statements, technical information, and recommendations contained herein are based upon testing believed to be reliable, but the accuracy and completeness thereof is not guaranteed.
WARRANTY: Specified Technologies Inc. manufactures its goods in a manner to be free of defects. Should any defect occur in its goods (within one year), Specified Technologies Inc., upon prompt notification, will at its option, exchange or repair the goods or refund the purchase price.
LIMITATIONS AND EXCLUSIONS: THIS WARRANTY IS IN LIEU OF ALL OTHER REPRESENTATIONS EXPRESSED OR IMPLIED (INCLUDING THE IMPLIED WARRANTIES OF MERCHANTABILITY OR FITNESS FOR USE) AND UNDER NO CIRCUMSTANCES SHALL SPECIFIED TECHNOLOGIES INC. BE RESPONSIBLE FOR ANY INCIDENTAL OR CONSEQUENTIAL PROPERTY DAMAGE OR LOSSES. PRIOR TO USE, THE USER SHALL DETERMINE THE SUITABILITY OF THE PRODUCT FOR ITS INTENDED USE, AND THE USER ASSUMES ALL RISKS AND LIABILITY FOR SUBSEQUENT USE. No statement or recommendation not contained herein shall have any force or effect unless in an agreement signed by officers of seller and manufacturer.

MADE IN USA • PRINTED IN USA – COPYRIGHT © 2016 SPECIFIED TECHNOLOGIES INC.

 Specified
Technologies
Inc.
THE FIRESTOP AUTHORITY

Somerville, NJ 08876 USA
 US Toll Free: (800) 992-1180
 Outside US: + 1 908 526 8000
www.stifirestop.com