



# GRL18S-N1331

GR18

CYLINDRICAL PHOTOELECTRIC SENSORS

**SICK**  
Sensor Intelligence.



Illustration may differ



### Ordering information

Type	Part no.
GRL18S-N1331	1059538

Other models and accessories → [www.sick.com/GR18](http://www.sick.com/GR18)

### Detailed technical data

#### Features

<b>Functional principle</b>	Photoelectric retro-reflective sensor
<b>Functional principle detail</b>	With minimum distance to reflector (dual lens system)
<b>Dimensions (W x H x D)</b>	18 mm x 18 mm x 38.1 mm
<b>Housing design (light emission)</b>	Cylindrical
<b>Thread diameter (housing)</b>	M18 x 1
<b>Optical axis</b>	Axial
<b>Sensing range max.</b>	0.03 m ... 7.2 m <sup>1)</sup>
<b>Sensing range</b>	0.06 m ... 6 m <sup>1)</sup>
<b>Type of light</b>	Visible red light
<b>Light source</b>	PinPoint LED <sup>2)</sup>
<b>Light spot size (distance)</b>	Ø 175 mm (7 m)
<b>Wave length</b>	650 nm
<b>Adjustment</b>	None
<b>Indication</b>	
	LED green    Operating indicator Static on: power on
	LED yellow    Status of received light beam Static on: object not present Static off: object present

<sup>1)</sup> Reflector PL80A.

<sup>2)</sup> Average service life: 100,000 h at T<sub>U</sub> = +25 °C.

## Mechanics/electronics

<b>Supply voltage <math>U_B</math></b>	10 V DC ... 30 V DC <sup>1)</sup>
<b>Ripple</b>	< 5 V <sub>pp</sub> <sup>2)</sup>
<b>Current consumption</b>	30 mA
<b>Switching output</b>	NPN
<b>Switching mode</b>	Light switching
<b>Signal voltage NPN HIGH/LOW</b>	Approx. $V_S / \leq 3$ V
<b>Output current <math>I_{max}</math></b>	$\leq 100$ mA <sup>3)</sup>
<b>Response time</b>	< 500 $\mu$ s <sup>4)</sup>
<b>Switching frequency</b>	1,000 Hz <sup>5)</sup>
<b>Connection type</b>	Cable, 3-wire, 2 m <sup>6)</sup>
<b>Cable material</b>	Plastic, PVC
<b>Circuit protection</b>	A <sup>7)</sup> B <sup>8)</sup> D <sup>9)</sup>
<b>Protection class</b>	III
<b>Polarisation filter</b>	✓
<b>Housing material</b>	Metal, Nickel-plated brass and ABS
<b>Optics material</b>	Plastic, PMMA
<b>Enclosure rating</b>	IP67
<b>Items supplied</b>	Fastening nuts (2 x)
<b>Electromagnetic compatibility (EMC)</b>	EN 60947-5-2
<b>Ambient operating temperature</b>	-25 °C ... +55 °C <sup>10)</sup>
<b>Ambient temperature, storage</b>	-40 °C ... +70 °C
<b>UL File No.</b>	NRKH.E348498 & NRKH7.E348498

<sup>1)</sup> Limit values. Operated in short-circuit protected network: max. 8 A.

<sup>2)</sup> May not exceed or fall below  $U_V$  tolerances.

<sup>3)</sup> At  $U_V > 24$  V or ambient temperature > 49 °C,  $I_A$  max. = 50 mA.

<sup>4)</sup> Signal transit time with resistive load.

<sup>5)</sup> With light/dark ratio 1:1.

<sup>6)</sup> Do not bend below 0 °C.

<sup>7)</sup> A =  $V_S$  connections reverse-polarity protected.

<sup>8)</sup> B = inputs and output reverse-polarity protected.

<sup>9)</sup> D = outputs overcurrent and short-circuit protected.

<sup>10)</sup> At  $U_V \leq 24$  V and  $I_A < 50$  mA.

## Classifications

<b>ECLASS 5.0</b>	27270902
<b>ECLASS 5.1.4</b>	27270902
<b>ECLASS 6.0</b>	27270902
<b>ECLASS 6.2</b>	27270902
<b>ECLASS 7.0</b>	27270902
<b>ECLASS 8.0</b>	27270902
<b>ECLASS 8.1</b>	27270902

<b>ECLASS 9.0</b>	27270902
<b>ECLASS 10.0</b>	27270902
<b>ECLASS 11.0</b>	27270902
<b>ECLASS 12.0</b>	27270902
<b>ETIM 5.0</b>	EC002717
<b>ETIM 6.0</b>	EC002717
<b>ETIM 7.0</b>	EC002717
<b>ETIM 8.0</b>	EC002717
<b>UNSPSC 16.0901</b>	39121528

### Connection type

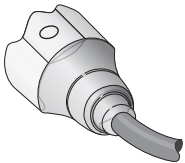

### Connection diagram

Cd-044

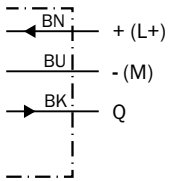

### Characteristic curve

GRL18S

Operating reserve

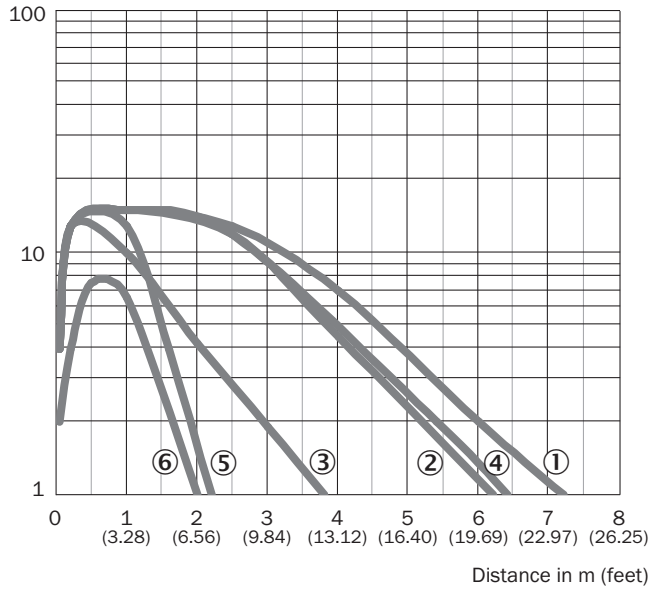

- ① Reflector PL80A
- ② Reflector PL40A
- ③ Reflector PL20A
- ④ Reflector P250
- ⑤ Reflector PL22
- ⑥ Reflective tape REF-Plus 3436

### Light spot size

GRL18S

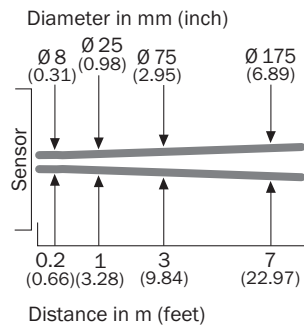

### Sensing range diagram

GRL18S

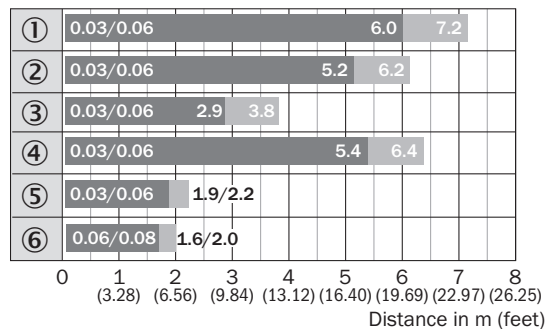

■ Sensing range    ■ Sensing range max.

- ① Reflector PL80A
- ② Reflector PL40A
- ③ Reflector PL20A
- ④ Reflector P250
- ⑤ Reflector PL22
- ⑥ Reflective tape REF-Plus 3436

### Response range

GRL18S

Parallel operating range y in mm (inch)

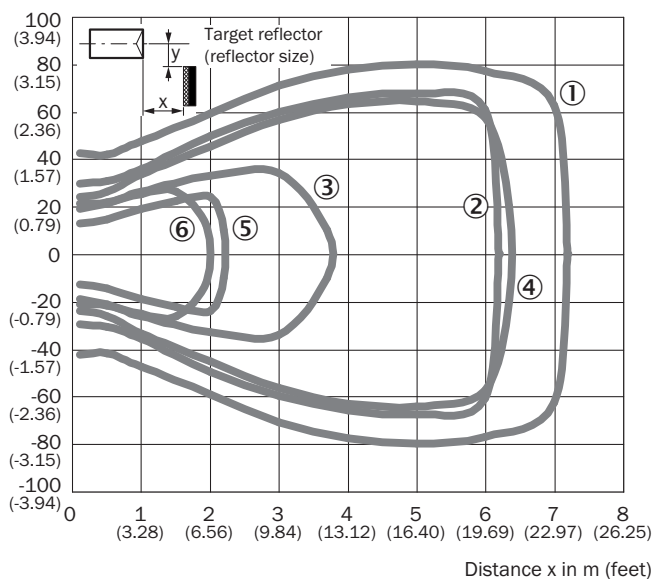

- ① Reflector PL80A
- ② Reflector PL40A
- ③ Reflector PL20A
- ④ Reflector P250
- ⑤ Reflector PL22
- ⑥ Reflective tape REF-Plus 3436

Dimensional drawing (Dimensions in mm (inch))



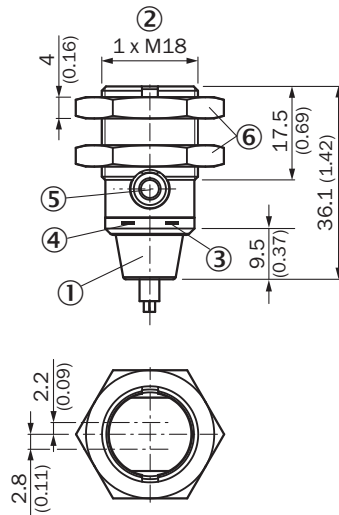

GR18S, metal, cable, straight



- ① Connection cable 2 m
- ② Threaded mounting hole M18 x 1
- ③ LED indicator yellow
- ④ LED indicator green
- ⑤ Dummy plug
- ⑥ Fastening nuts (2x); width across 24, metal

Recommended accessories

Other models and accessories → [www.sick.com/GR18](http://www.sick.com/GR18)

	Brief description	Type	Part no.
<b>Mounting brackets and plates</b>			
	Mounting bracket for M18 sensors, steel, zinc coated, without mounting hardware	BEF-WN-M18	5308446
	Universal mounting bracket for reflectors, steel, zinc coated	BEF-WN-REFX	2064574
<b>Reflectors</b>			
	Rectangular, screw connection, 51 mm x 61 mm, PMMA/ABS, Screw-on, 2 hole mounting	P250	5304812
<b>Others</b>			
	<ul style="list-style-type: none"> <li>• <b>Connection type head A:</b> Male connector, M8, 3-pin, straight, A-coded</li> <li>• <b>Description:</b> Unshielded</li> <li>• <b>Connection systems:</b> Screw-type terminals</li> <li>• <b>Permitted cross-section:</b> 0.14 mm<sup>2</sup> ... 0.5 mm<sup>2</sup></li> </ul>	STE-0803-G	6037322

## SICK AT A GLANCE

SICK is one of the leading manufacturers of intelligent sensors and sensor solutions for industrial applications. A unique range of products and services creates the perfect basis for controlling processes securely and efficiently, protecting individuals from accidents and preventing damage to the environment.

We have extensive experience in a wide range of industries and understand their processes and requirements. With intelligent sensors, we can deliver exactly what our customers need. In application centers in Europe, Asia and North America, system solutions are tested and optimized in accordance with customer specifications. All this makes us a reliable supplier and development partner.

Comprehensive services complete our offering: SICK LifeTime Services provide support throughout the machine life cycle and ensure safety and productivity.

For us, that is “Sensor Intelligence.”

## WORLDWIDE PRESENCE:

Contacts and other locations –[www.sick.com](http://www.sick.com)