



VSPI-4F2111

Inspector

2D MACHINE VISION

SICK
Sensor Intelligence.



Ordering information

Type	Part no.
VSPI-4F2111	1047913

Other models and accessories → www.sick.com/Inspector



Detailed technical data

Features

Task	Detecting - Standard objects Measuring - Dimension, contour and volume Measuring - Number Identifying - OCR Identifying - Pattern Determining position - 2D position determination
Technology	2D snapshot
Product category	Configurable
Toolkit	Object locator Contour Pixel counter Edge pixel counter Pattern
Sensor	CMOS matrix sensor, grayscale values
Optical focus	Adjustable focus (manually)
Working distance	≥ 50 mm
Operating distance with internal illumination	50 mm ... 200 mm
Field of view of internal illumination	22 mm x 15 mm ... 79 mm x 58 mm
Illumination	Integrated
Illumination color	White,
LED class	Risk group 1 (low risk, IEC62471 : 2006)
Spectral range	Approx. 400 nm ... 750 nm
Offline support	Emulator
Lens	S-mount
	Optical format 1/3"
	Focal length 10 mm

Mechanics/electronics

Connection type	M12, 12-pin male connector
------------------------	----------------------------

¹⁾ With front window mounted.

	M12, 4-pin female connector
Supply voltage	24 V DC, $\pm 20\%$
Ripple	$< 5 V_{pp}$
Current consumption	$< 450\text{ mA}$, without output load
Enclosure rating	IP67 ¹⁾
Housing material	Aluminum
Window material	PMMA
Weight	350 g
Dimensions (L x W x H)	100 mm x 53 mm x 38 mm

¹⁾ With front window mounted.

Performance

Sensor resolution	640 px x 480 px
Scan/frame rate	40 fps ¹⁾
Number of inspections	32
Reference images	32 objects

¹⁾ Max. 250 fps.

Interfaces

EtherNet/IP™	✓
Data transmission rate	100 Mbit/s
Operator interfaces	Inspector Viewer
Configuration software	SOPAS ET
Data storage and retrieval	Log for 30 images, record images on PC, store images to FTP
Ethernet communication	EtherNet/IP™
Digital input	4 inputs (24 V)
Configurable inputs	External trigger, encoder input, External teach, reference object selection
Digital output	3 digital outputs, 24 V (B-type)
Configurable outputs	Output by logical expressions, Additional image storage possibility via FTP
Output current	$\leq 100\text{ mA}$
Standard outputs	No object detected, Everything OK, Detail error
Maximum encoder frequency	40 kHz
External illumination	5 V TTL
I/O box extension	5 x inputs for object selection, 16 outputs

Ambient data

Shock load	EN 60068-2-27
Vibration load	IEC 60068-2-6
Ambient operating temperature	0 °C ... +45 °C ¹⁾
Storage temperature	-20 °C ... +70 °C ¹⁾

¹⁾ Relative humidity: 35% ... 85%, 95% in storage.

Classifications

ECLASS 5.0	27310205
-------------------	----------

ECLASS 5.1.4	27310205
ECLASS 6.0	27310205
ECLASS 6.2	27310205
ECLASS 7.0	27310205
ECLASS 8.0	27310205
ECLASS 8.1	27310205
ECLASS 9.0	27310205
ECLASS 10.0	27310205
ECLASS 11.0	27310205
ECLASS 12.0	27310205
ETIM 5.0	EC001820
ETIM 6.0	EC001820
ETIM 7.0	EC001820
ETIM 8.0	EC001820
UNSPSC 16.0901	43211731

Dimensional drawing (Dimensions in mm (inch))

Standard

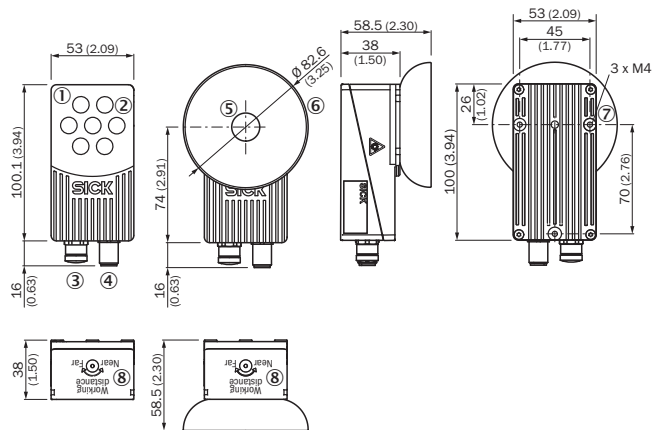

- ① Front screen: standard, flex
- ② Ring lighting
- ③ Ethernet connection M12, 4-pin, female
- ④ Power connection M12, 12-pin, male
- ⑤ Front screen: dome
- ⑥ Dome light
- ⑦ Mounting hole M4
- ⑧ Focus

Field of view

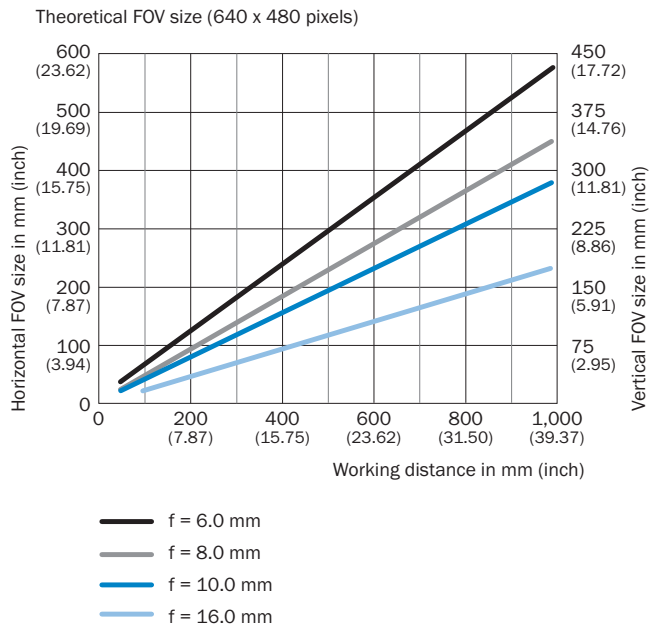

Connection type

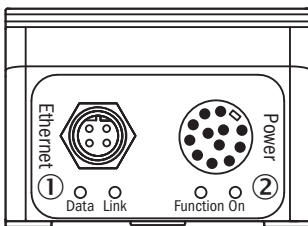

- ① Ethernet connection M12, 4-pin, female
- ② Power connection M12, 12-pin, male

Connection diagram

M12 connection diagram, 12-pin

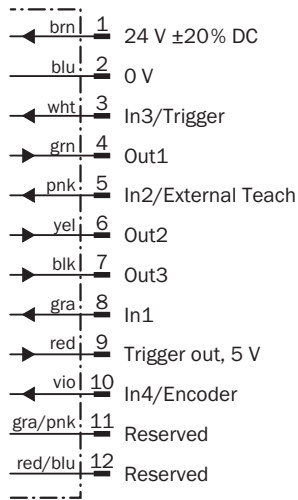



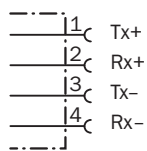





Ethernet connection diagram



Recommended accessories

Other models and accessories → www.sick.com/Inspector

	Brief description	Type	Part no.
Lenses and accessories			
	Replaces the front screen and generates even and uniform illumination, for glossy surfaces, PMMA	Inspector Flex Dome	2050678
	Exchangeable lens, focal length 6 mm, Round connector M12 x 0.5	OBJ-B06025BA	2049668
	Exchangeable lens, focal length 16 mm, including spacer ring, Round connector M12 x 0.5	OBJ-B16018BA	2049418
Optical filters			
	Color filter blue (468 nm ± 62 nm) for variants with exchangeable lens and front window, PMMA	Inspector Flex blue color filter	2050676
	Color filter green (544 nm ± 53 nm) for variants with exchangeable lens and front window, PMMA	Inspector Flex green color filter	2050677

	Brief description	Type	Part no.
	Color filter red for variants with exchangeable lens and front window, PMMA	Inspector Flex red color filter	2050675
Others			
	<ul style="list-style-type: none"> • Connection type head A: Female connector, M12, 12-pin, straight • Connection type head B: Flying leads • Signal type: Sensor/actuator cable • Cable: 5 m, 12-wire, cable ends blue/red, gray/pink and red isolated separately, PUR, halogen-free • Description: Sensor/actuator cable, shielded • Connection systems: Flying leads 	DOL-1212-G05MAS01	6036556
	<ul style="list-style-type: none"> • Connection type head A: Male connector, M12, 4-pin, straight, D-coded • Connection type head B: Male connector, RJ45, 4-pin, straight • Signal type: Ethernet, PROFINET • Cable: 2 m, 4-wire, PUR, halogen-free • Description: Ethernet, PROFINET, shielded • Application: Drag chain operation, Zones with oils and lubricants 	YM2D24-020PN1MRJA4	2106182

Recommended services

Additional services → www.sick.com/Inspector

	Type	Part no.
Commissioning		
<ul style="list-style-type: none"> • Product area: 2D machine vision • Range of services: Inspection of connection, fine adjustment, optimization of parameters of SICK product as well as tests, set-up of previously defined functions of image settings, object locator, detailed inspections, output settings and results • Duration: Additional work will be invoiced separately 	Inspector commissioning	1612238
Maintenance		
<ul style="list-style-type: none"> • Product area: 2D machine vision • Range of services: Inspection, analysis and restoring of defined functions, set-up of previously defined functions of image settings, object locator, detailed inspections, output settings and results • Duration: Additional work will be invoiced separately 	Inspector maintenance	1612242
Extended warranty		
<ul style="list-style-type: none"> • Product area: Machine vision, LiDAR sensors, safety camera sensors, Safety laser scanners, Safety radar sensors, Radar sensors, Fixed mount barcode scanners, Image-based code readers, RFID, Mobile handheld scanners • Range of services: The services correspond to the scope of the statutory manufacturer warranty (SICK general terms of delivery). • Duration: Five-year warranty from delivery date. 	Extended warranty for a total of five years from delivery date	1680671

SICK AT A GLANCE

SICK is one of the leading manufacturers of intelligent sensors and sensor solutions for industrial applications. A unique range of products and services creates the perfect basis for controlling processes securely and efficiently, protecting individuals from accidents and preventing damage to the environment.

We have extensive experience in a wide range of industries and understand their processes and requirements. With intelligent sensors, we can deliver exactly what our customers need. In application centers in Europe, Asia and North America, system solutions are tested and optimized in accordance with customer specifications. All this makes us a reliable supplier and development partner.

Comprehensive services complete our offering: SICK LifeTime Services provide support throughout the machine life cycle and ensure safety and productivity.

For us, that is “Sensor Intelligence.”

WORLDWIDE PRESENCE:

Contacts and other locations –www.sick.com